

Combinational Logic

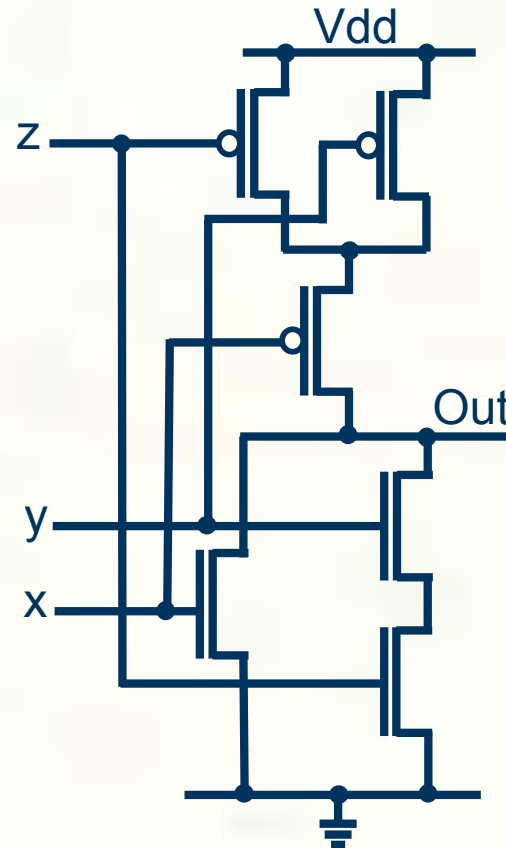

Multi-input gates - $(x+(y*z))'$

x	y	z	out
0	0	0	1
0	0	1	1
0	1	0	1
0	1	1	0
1	0	0	0
1	0	1	0
1	1	0	0
1	1	1	0



Very easy with inverting gates



Half Adder

- 1-bit addition ($x + y$)
 - outputs: sum s and carry c
 - $s = xy' + x'y$ (x XOR y or $x \oplus y$)
 - $c = xy$

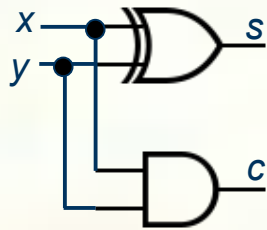

x	y	s	c
0	0	0	0
0	1	1	0
1	0	1	0
1	1	0	1



Full 1-bit adder

- Need a carry in c_i

$$\begin{aligned} s &= x'y c_i' + x y' c_i' + x'y' c_i + x y c_i \\ &= c_i' (x'y + x y') + c_i (x y + x'y') \\ &= c_i' (x'y + x y') + c_i (x'y + x y')' \\ &= c_i \oplus (x \oplus y) \end{aligned}$$

$$\begin{aligned} c_o &= x'y c_i + x y' c_i + x y c_i' + x y c_i \\ &= c_i (x'y + x y') + x y (c_i' + c_i) \\ &= c_i (x \oplus y) + x y \end{aligned}$$

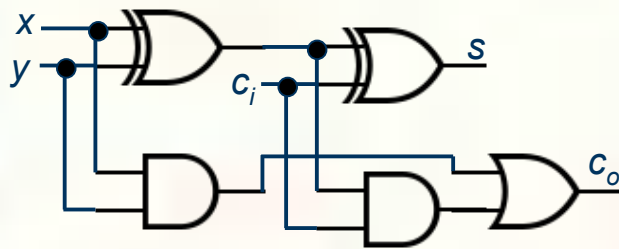

x	y	c_i	s	c_o
0	0	0	0	0
0	0	1	1	0
0	1	0	1	0
0	1	1	0	1
1	0	0	1	0
1	0	1	0	1
1	1	0	0	1
1	1	1	1	1



CMOS adder

For the carry, we can first use De Morgan's laws

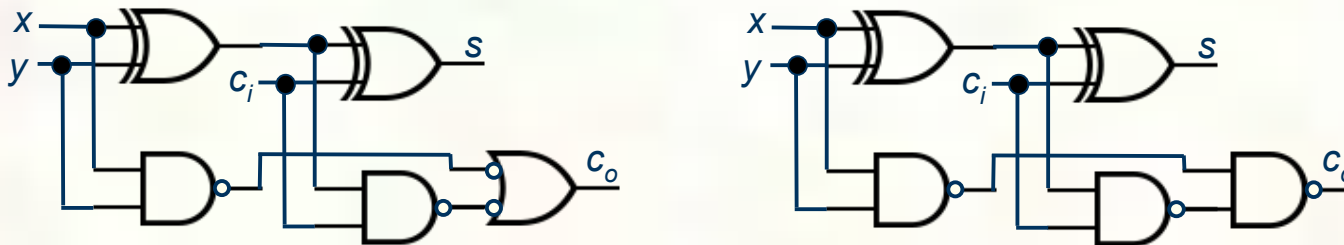

For the **xor**, recall that $a \text{ xor } b = ab' + a'b$ and $(a \text{ xor } b)' = ab + a'b'$

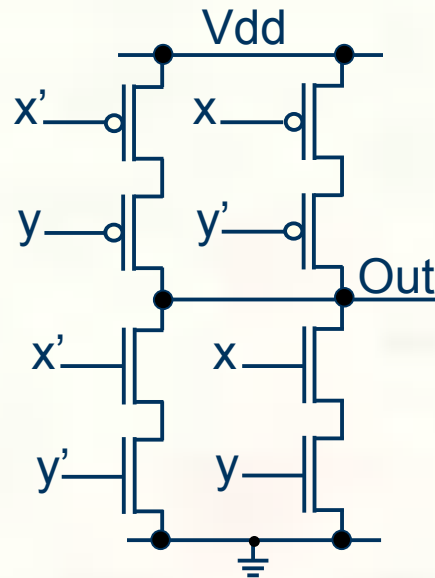



Multiplexor

- A multiplexor (selector or mux) selects one of n inputs to be output

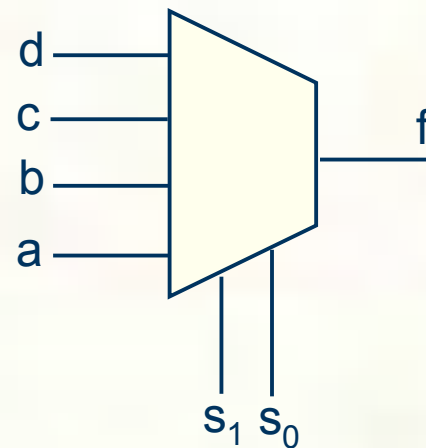

- Let's make it easy and start with a 2-input mux

- when $s = 0$, $f = a$
- when $s = 1$, $f = b$

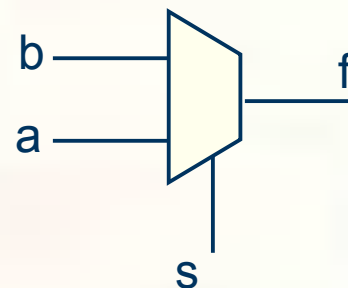



2 input Multiplexor design

<i>s</i>	<i>a</i>	<i>b</i>	<i>f</i>
0	0	0	0
0	0	1	0
0	1	0	1
0	1	1	1
1	0	0	0
1	0	1	1
1	1	0	0
1	1	1	1

$$\begin{aligned} f &= s'ab' + s'ab + sa'b + sab \\ &= s'a(b'+b) + sb(a'+a) \\ &= s'a + sb \end{aligned}$$

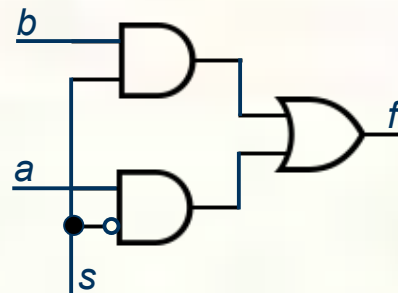



Making bigger muxes

You can design them directly, or just glue together smaller muxes:

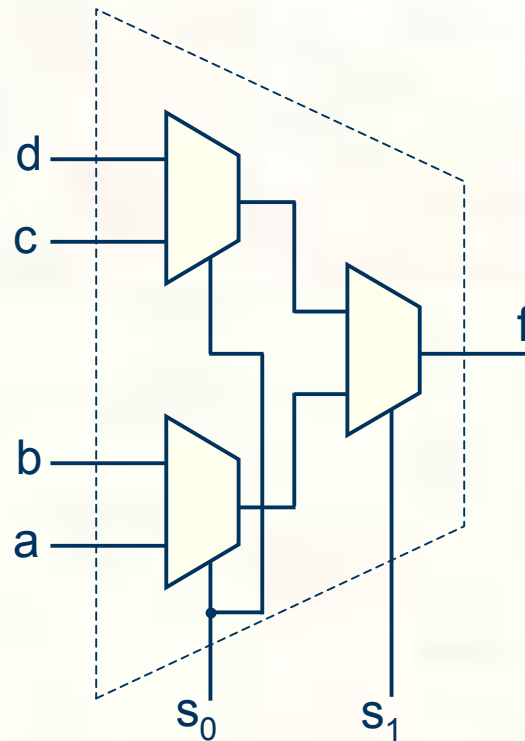



Decoders

- Decode an n -bit input to set output line $2^n - 1$

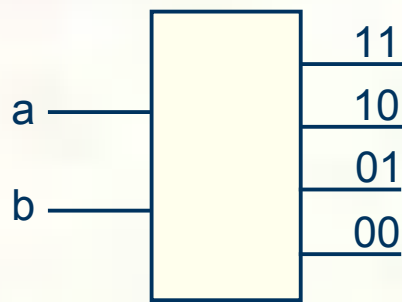

a	b	00	01	10	11
0	0	1	0	0	0
0	1	0	1	0	0
1	0	0	0	1	0
1	1	0	0	0	1

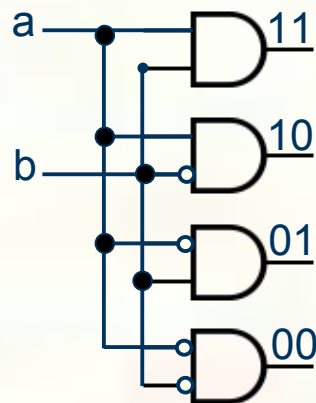



Programmable Logic Array (PLA)

- Since all Boolean functions can be expressed in sum of products form, we can implement a set of n input functions systematically in hardware using a PLA

